

3.3 HW-BA116ABK



MRV	LCAC			
	Smart Power	Super Match	R410A ON/OFF	R22 ON/OFF
√		√	√	

- Basic function: On/Off, Mode, Fan speed, Temperature
- Individual & Group control (Max 16 indoor units)
- Simple and Smart design, 86*86*15.8mm

- Parts and Functions

Interface Display

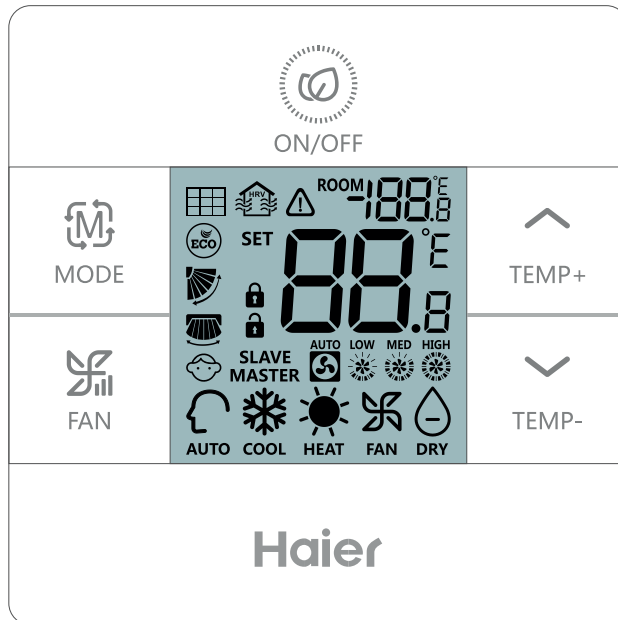

Full display

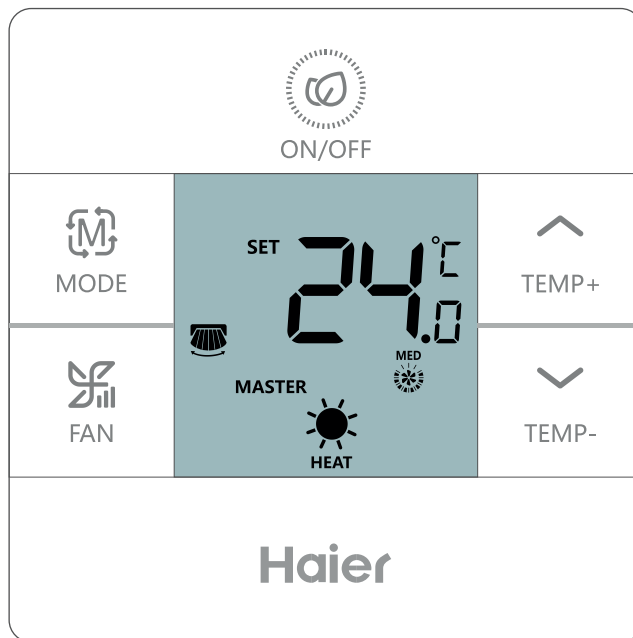



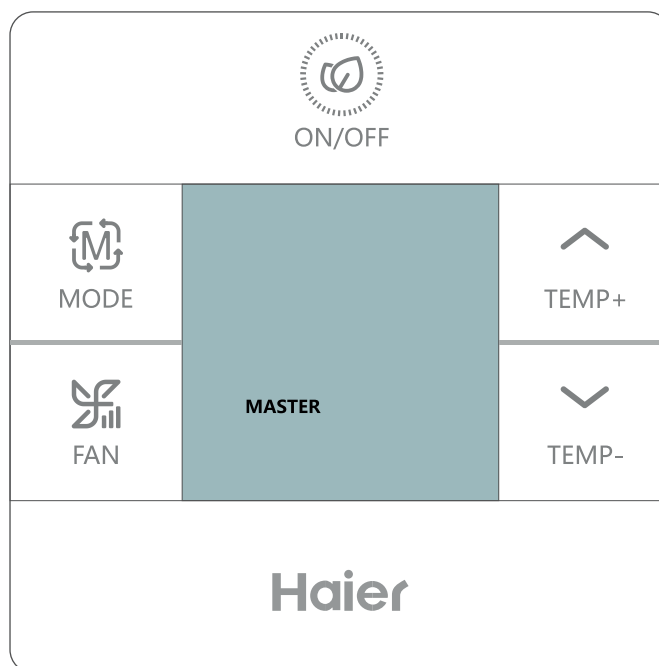





ON display



OFF display





























Icon

	<p>Room temp. display; ECO parameter display; Historic error code display; Parameter display; Central address display; Temp. compensation setting display; Mode combination setting display.</p>
	<p>Set temp. display; Forced cooling LL/ forced heating HH icon display; Current error code/unit No. display; Parameter checking unit No. display.</p>
	<p>Filter</p>
	<p>HRV(Heat Reclaim Ventilation), if HRV function is set, it will display this icon.</p>
	<p>Error icon</p>
	<p>ECO icon, if ECO function is set, it will display this icon.</p>
	<p>Central/lock</p>
	<p>UP/DOWN swing</p>
	<p>LEFT/RIGHT swing</p>
	<p>Child lock</p>

MASTER / SLAVE	Master/slave wired controller
 /  /  / 	Auto/low/middle/high fan speed
	Auto mode
	Cooling mode
	Heating mode
	Fan mode
	Dry mode

• Operation

Special function operation index

Function	Operational approach
Function selection	Under ON state, after turning on the back light, press  for 5s.
Forced cooling	Under cooling mode OFF state, press  for 5s, buzzer buzzing 2 times, and screen displaying LL
Forced heating	Under heating mode OFF state, press  for 5s, buzzer buzzing 2 times, and screen displaying HH
Child lock	After turning on the back light, press   together for 5s to set or cancel child lock, buzzer buzzing 1 time.
Temp. compensation	Under OFF state, after turning on the back light, press  for 5s, then adjust by  /  , and confirm by  .
Forced defrosting.	Under state of ON + heating mode + 30°C (if ECO mode is set, change temp. to max limit) + high fan speed, press  6 times within 5s, buzzer buzzing 3 times.
ECO- cooling	Eco cooling mode parameter adjusting: under ON state, cooling mode, 30°C set temp., press   together for 5s to enter adjustment; Parameters will be shown at first two 8 segments on the upper right corner of room temp. display area; Press  /  to adjust and press  to confirm.
ECO- heating	Eco heating mode parameter adjusting: under ON state, heating mode, 16°C set temp., press   together for 5s to enter adjustment; Parameters will be shown at first two 8 segments on the upper right corner of room temp. display area; Press  /  to adjust and press  to confirm.
Error inquiry	After turning on back light, press  for 5s to enter error inquiry state; under error inquiry state, press  for 5s to clear current and historic error code.
Wired controller mode setting	Under OFF state, after turning on back light, press  for 10s to enter setting, then press  /  for adjustment and press  for confirmation.
Shift from Celsius degree to Fahrenheit degree	Adjust set temp. to 30 degree Celsius (if ECO temp. limit is set, change to max temp.), then press  for 15s to change to Fahrenheit degree.
Shift from Fahrenheit degree to Celsius degree	Adjust set temp. to lowest degree Fahrenheit (if ECO temp. limit is set, change to min. temp.), then press  for 15s to change to Celsius degree.

Dip switch definition

8 bits dip switch (SW1)

SW1	ON	OFF	Default
Sw1-1	Slave wired controller	Master wired controller	OFF
Sw1-2	Displaying room temp.	Without displaying room temp.	OFF
Sw1-3	Collect ambient temp. from PCB of indoor	Collect ambient Temp. from wired controller	OFF
Sw1-4	Non-volatile memory invalid	Non-volatile memory valid	OFF
Sw1-5	Old protocol (models developed before Aug. 2013)	New protocol	OFF
Sw1-6	back light always on	back light on for 15s without operation	OFF
Sw1-7	UP/DOWN swing + LEFT/RIGHT swing	UP/DWON swing	OFF
Sw1-8	Reserved	Reserved	OFF

4 bits dip switch (SW2)

SW2	ON	OFF	Default
Sw2-1	Mode set limit	Normal	OFF
Sw2-2	Buzzer no buzzing when pressing key (buzzer normally when using remote control)	Normal	OFF
Sw2-3	Reserved	Reserved	OFF
Sw2-4	Reserved	Reserved	OFF



Initialization

Power on and starts initialization 2 seconds later, 88.8 on top right corner and 88.8 in the middle will alternately flash until initialization finished.



Audible alert



Press  to power on or power off, buzzer rings one time. When receiving other commands, also ring one time; if invalid command, no alert; If ring three times when sending commands to HW-BA1 from remote controller, it means there is conflicting setting.

Backlight and screensaver

- (1) Power on, back light comes on,  green light comes on; Power off, back light goes out,  green light goes out.
- (2) If SW1-6 is on, there is no screensaver, backlight is always on after power on, backlight goes out if no operations within 15s.
- (3) If SW1-6 is off, there is screensaver, backlight goes out if there is no operation within 15s after power on.

Key operations

Power on/off  Press  to power on or power off;





- Under the condition that unit is switched off in cooling mode, long press  for 5s, buzzer rings twice quickly and indoor unit enter forced cooling mode, "LL" flashes in ambient display area (on top right corner), press ON/OFF button or receiving remote signal to quit forced cooling mode.
- Under the condition that unit is switched off in heating mode, long press  for 5s, buzzer rings twice quickly, indoor unit enter forced heat in mode, "HH" flashes in ambient display area (on top right corner), press ON/OFF button or receiving remote signal to quit forced heating mode.

Mode key :

- Press  to switch mode.
- There is independent fan speed, temperature in each mode.

	Mode	Fan speed	Temperature
Initial State	Auto	Auto	24°C
	Cool	High	24°C
	Dehumidify	Auto	24°C
	Heating	Auto	24°C
	Fan	Low	No (Initial temperature is 24°C, changes according to indoor unit)











Fan speed key :

- There is 3 speed under fan mode, low, mid, and high, under other mode, there are 4 speed, low, mid, high, auto.
- Fan speed display, low , mid , high , auto 





Temp+/- key / :

- Press temperature+/- to change speed by 0.5°C;
- Temperature range under Auto, Cooling, Dehumidify, Heating: 16°C~30°C (If ECO is set, temperature range will change according to the setting parameters).
- Temperature is set independently under Auto, Cooling, Dehumidify and Heating mode, setting temperature under each mode will be saved even mode is changed or power off.
- Under fan mode, Temp+/- key doesn't work;











Swing function (By change SW1-7 to make let-right swing available or not) :

Under ON state, long press  for 5s when unit is running to enter cycle function, all function icons displays,  swing icon flashes(default), press  /  to switch different functions:  up-down swing →  ECO →  filter (only when there is filter tip, this function will be in the function cycle) →  air exchange →  left-right swing (when SW1-7 is on) →  up-down swing; Currently chosen icon flashes, press  to choose the selected function; if this operation has been set, repeating this operation will deselect this function.





Filter clean reminding and filter reset :

cumulative time of filter is up,  display on wired controller screen, when unit is running, make backlight on and long press  for 5s to enter cycle function, when  flashes, press  to select filter reset.



Adjust ECO parameters :

- Adjust cooling ECO parameters: Switch on indoor unit, set cooling mode, 30°C, long press  +  for 5s, parameters will be displayed by 2 eight-segment LED in ambient display area (top right corner of screen). Press  /  to change parameters and press  to select. Default value is 23°C, so temperature range under cooling and dehumidify mode is 23-30°C.
- Adjust heating ECO parameters: Switch off indoor unit, set heating mode, 16°C, long press  +  for 5s, parameters will be displayed by 2 eight-segment LED in ambient display area (top right corner of screen). Press  /  change parameters and press  to select. Default value is 26°C, so temperature range under heating mode is 16-26°C.



Child lock:

Press  and  at the same time and hold for 5s to set Child lock function, when child lock function is successfully set  will display and buzzer rings one time. If child lock function is valid now, press  and  at the same time and hold for 5s to cancel Child lock function, child lock icon disappears and buzzer rings one time.





Central/Lock function:

- If  displays on screen, it means central lock, unit can only be controlled by central controller, wired controller is invalid now. If screensaver is there, press any key to quit. If parameters changed by central controller, parameters on wired controller will automatically change.
- If  displays on screen, wired controller can only switch on/off indoor unit.

Fahrenheit setting and display:

- Highest Fahrenheit display is 99°F even when ambient temperature exceeds 37°C.
- Under lowest Fahrenheit temperature (lowest temperature is 60°F when ECO is not set, if ECO is set, lowest temperature is the lower limit of ECO mode), long press  for 15s to switch to Celsius; highest temperature is 30°C (it's 30°C if ECO is set; it's upper limit of ECO mode), long press  for 15s to switch to Fahrenheit.



Set temperature compensation:

- When unit is off, make backlight on, long press  for 5s to set temperature compensation. Temperature value will display by the first eight-segment LED which is in the ambient display area, range is $-4^{\circ}\text{C}\sim+4^{\circ}\text{C}$, default is 0°C , set by pressing  / , and press  to confirm.
- Even Fahrenheit display is chosen Celsius is used during communication. Setting range is $-8^{\circ}\text{C}\sim+8^{\circ}\text{C}$.

Forced defrosting:

Under the condition that indoor unit working at heating mode, high speed, 30°C (If ECO is set, use the upper limit temperature of ECO mode), press  6 times, within 5S, buzzer rings 3 times and wired controller send forced defrosting command to indoor unit.





How to check error:

- If there is error  will display.
- Check error: Make backlight on, long press  for 5s, history error will be displayed by 2 eight-segment LED which is on top right corner, current error will be displayed by 2 eight-segment LED which is in the middle area, if no error, display "--", the eight-segment LED after decimal shows unit sequence number, 0~F corresponds to 00~15 indoor unit.
- Clear error codes: Long press  for 5S under error inquiry mode to clear current error and history error, press any key or no operation within 10S to quit error inquiry; press ON/OFF to quit error inquiry directly and unit will be switched on or switched off.
- Communication error: Communication with indoor unit is abnormal for continuous 4 minutes, wired controller shows error 07, if communication recovers, error will disappear automatically.
- If indoor unit is using temperature sensor in wired controller, temperature sensor of wired controller is short circuit or open circuit for continuous 2 minutes, wired controller show error 01.
- Other error pls refer to error list in indoor user manual.





Mode restriction function:

- If SW2-1 is on, mode restriction function valid. Mode key is invalid, press mode key, buzzer rings but mode cannot be changed, current mode will flash 3S to tell that current mode cannot be changed.
- Under mode restriction mode, mode cannot be changed by mode key on wired controller, but mode can be changed by other source, like remote controller send signal to wired controller, central controller, change indoor mode directly by remote controller etc.
- After changing dip switch, must power off and on again to make new setting valid.



Check parameters (only applies to some models):

- Make backlight on, long press  for 10s to check parameters, double eight-segment LED in the middle shows indoor address(00-15), the eight-segment LED after decimal display AbCdEF, "188" on top right corner shows detailed parameters.
- Press  to switch indoor sequence no. Press  and  to switch AbCdEF.
- Quit inquiry mode if no operation within continuous 10s; press mode key under parameter inquiry mode to quit directly instead of changing mode; press ON/OFF under parameter inquiry mode, unit will be switched on/off.

Indoor address inquiry and setting (Applies to some model):

- Make backlight on, long press  for 10s to check address and current status of indoor unit, the eight-segment LED after decimal display 0~F which stands for indoor unit sequence no 00~15. double eight-segment LED in the middle shows indoor communication address(00-15), "188" on top right corner shows central address.
- Communication address 0~63, central address 0~127.
- Press  to change indoor address, if communication address flashes, it means it can be changed by wired controller, press  /  to change, press  to confirm, and start to change another indoor address.
- No operation within continuous 10s to quit inquiry and setting, if press ON/OFF under inquiry and setting mode, quit and indoor unit will be switched on/off.

Mode combination setting:

- Keep indoor unit off, make backlight on, long press  for 10 to enter mode combination setting. In temperature display area relevant value will display, default is 0, press  to change.
- 0-Auto-Heat-Dehumidify-Cool-Fan
 1-Cool -Heat-Dehumidify
 2-Cool
 3-Heat
 4-Heat -Dehumidify -Cool -Fan
 5-Dehumidify -Cool -Fan
 6-Heat-Fan
- There is mode combination in indoor PCB, choose the intersection between above mode combination and indoor mode combination.

Wired Controller Wiring Instruction

Wiring Connections of Wire Controller

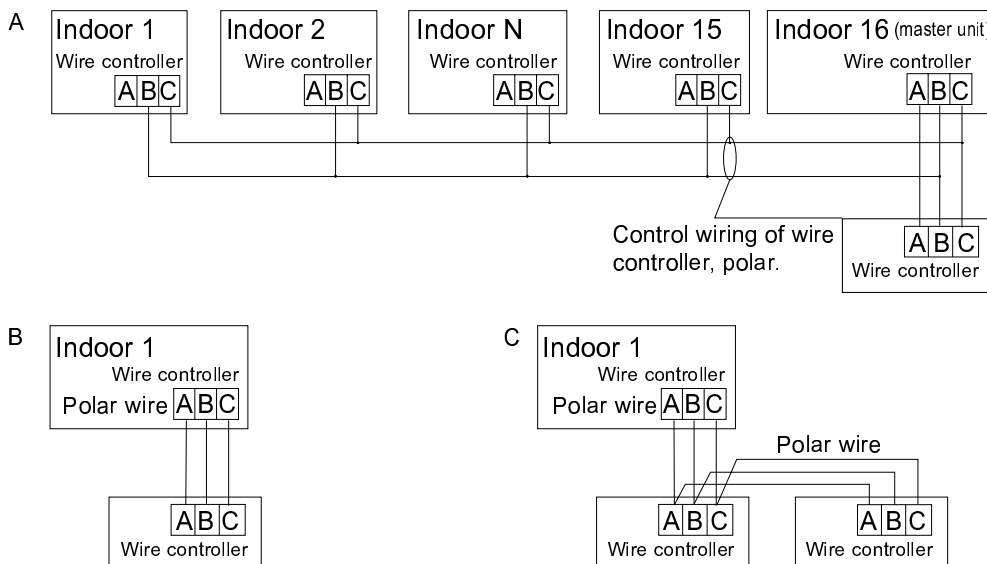

Notice:

For wired controller connection, please do follow the corresponding indoor unit installation manual's instruction.

Communication wiring

Communication wiring length (m/ft)	Dimensions of wiring
≤ 250m	0.75mm ² x3-core shielded wire

*One side of the shielded sheet of communication wire must be earthed.

Wiring diagrams

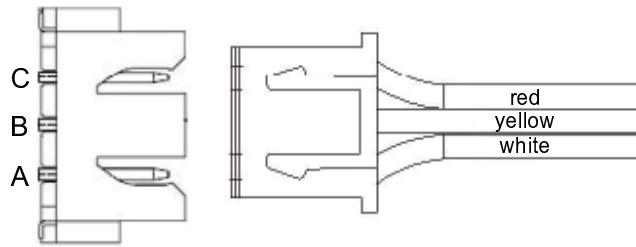

Installation diagrams

<p>1. To take the front panel and back panel apart by screw driver.</p>	
<p>2. To fix the back panel.</p>	
<p>3. Insert connector of wire harness into terminal block.</p>	
<p>4. Finally, recombine the front panel and back panel, just like below shows</p>	